

MMPH

INDUSTRIES®



Installation Guide

Antenna Bracket Assembly

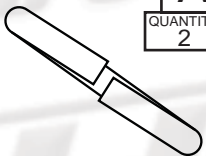

FITS: BEE III, Enforcer, Python III, Ranger

PT# ai.950963

Installation Materials

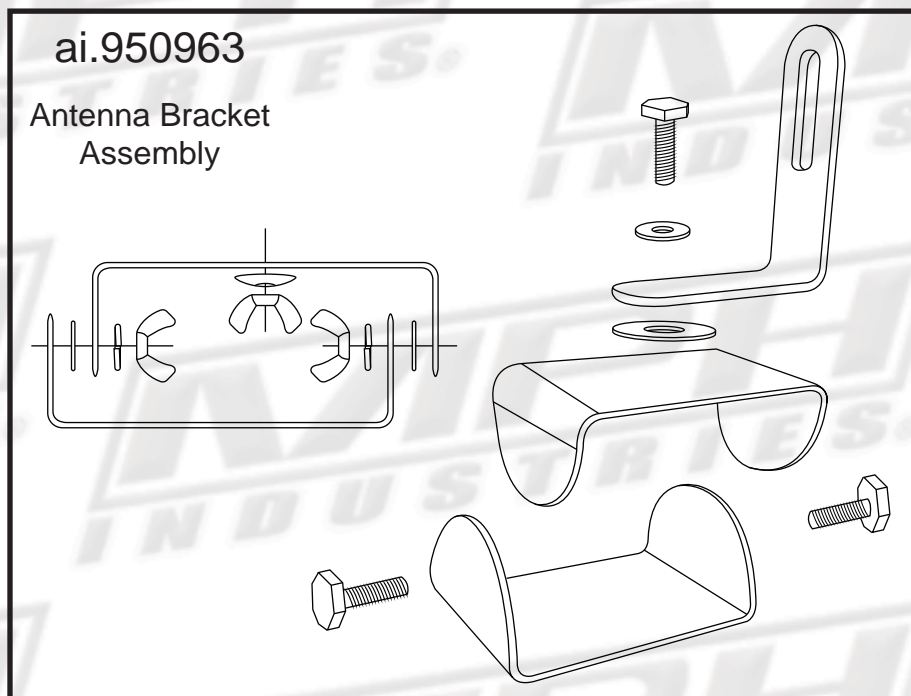
<p>908342</p> <p>A</p> <p>QUANTITY 2</p>  <p>Helical Lock Washer 1/4"</p>	<p>900024</p> <p>B</p> <p>QUANTITY 2</p>  <p>Nylon Washer .219x1.0x.03</p>	<p>902370</p> <p>C</p> <p>QUANTITY 1</p>  <p>Shoulder Washer</p>	<p>900025</p> <p>D</p> <p>QUANTITY 1</p>  <p>Disc Spring Washer</p>	<p>903542</p> <p>E</p> <p>QUANTITY 3</p>  <p>Wing Nut 1/4-20</p>
---	--	---	---	--

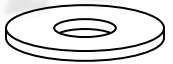
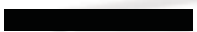
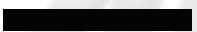

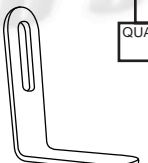
<p>903543</p> <p>F</p> <p>QUANTITY 3</p>  <p>Hex Screw 1/4-20 x .62</p>	<p>903356</p> <p>G</p> <p>QUANTITY 3</p>  <p>Flat Nylon Washer 1/4" x .032"</p>
<p>680004</p> <p>H</p> <p>QUANTITY .6</p>  <p>Dual Lock Pad</p>	<p>680005</p> <p>I</p> <p>QUANTITY .6</p>  <p>Dual Lock Pad</p>
<p>903872</p> <p>J</p> <p>QUANTITY 2</p>  <p>Antenna Windshield Bracket</p>	<p>903805</p> <p>K</p> <p>QUANTITY 1</p>  <p>Angle Slotted Bracket</p>

Installation Process

1

Find both parts of the Antenna Windshield Bracket (J). The ends of the bracket will be one inside the other (both of them are the exact same).

2

With the Antenna Windshield Bracket (J) being set one inside the other, start a Hex Screw (F) through one side of the Antenna Windshield Bracket (J). Place a Nylon Washer (G) between the two bracket ends. Following a Lock Washer (A) and securing with a Wing Nut (E). Repeat for other side.

3

Next, take the last Hex Screw (F) and fit a Nylon Washer (G) onto the stud. Place this through the hole of the Angle Slotted Bracket (K) and through the Flat Nylon Washer (B).

4

Put through the top hole of the Antenna Windshield Bracket (J) followed by the Disc Washer (D) and secure with a Wing Nut (E)

5

With the antenna in hand, fit the Shoulder Washer (C) onto the stud of the antenna. Put through the slot of the Angle Slotted Bracket (K) and fit a Nylon Washer (B) onto the stud separating the bracket from the knob included with the antenna kit.

6

Pick a place in the vehicle to mount the bracket. Take the Dual Lock Pad (H)(I) and remove the adhesive covering to put onto the bottom of the Antenna Windshield Bracket (J). Mount in the area of the vehicle by removing the bottom adhesive strip.

7

Universal Antenna Bracket Assembly

Part # ai.950963

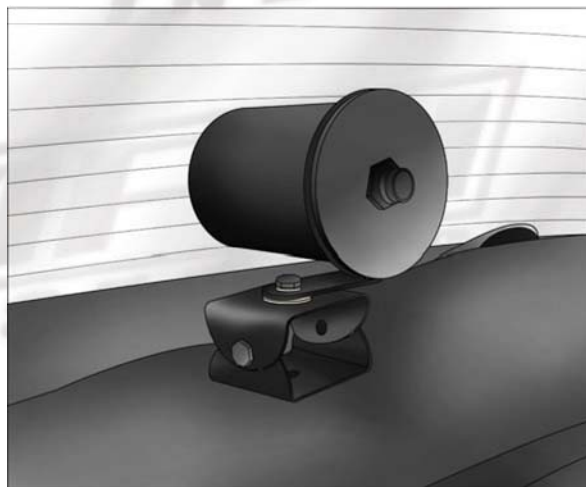

WPH INDUSTRIES®

ITEM	QUANTITY	PART NUMBER	DESCRIPTION
A	2	908342	Helical Lock Washer 1/4
B	2	900024	Nylon Washer .219x1.0x.0.3
C	1	902370	Shoulder Washer
D	1	900025	Disc Spring Washer
E	3	903542	Wing Nut 1/4-20
F	3	903543	Hex Screw 1/4-20 x .62
G	3	903356	Flat Nylon Washer 1/4 x .032
H	.6	680004	Dual Lock Pad
I	.6	680005	Dual Lock Pad
J	2	903872	Antenna Windshield Bracket
K	1	903805	Angle Slotted Bracket

