

MMPH

INDUSTRIES®

Installation Guide

Harley Davidson License Plate Bracket

PT# ai.951104

Installation Materials

ai.951104

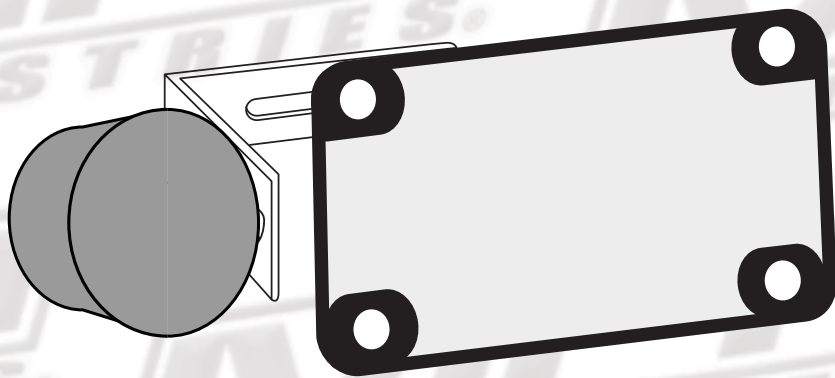

Harley Davidson
License Plate
Bracket

909106

A

QUANTITY
1

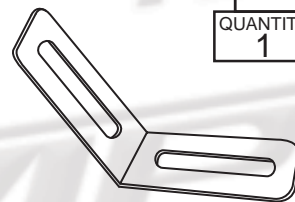

Angle Antenna Bracket

910067

B

QUANTITY
1

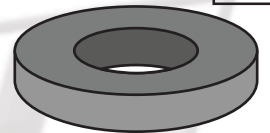

Neoprene Washer

910068

C

QUANTITY
2

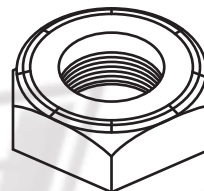

1/4-20 Nylon Ins. Nut

908340

D

QUANTITY
3



1/4-20 Regular
Plain Washer

903798

E

QUANTITY
1

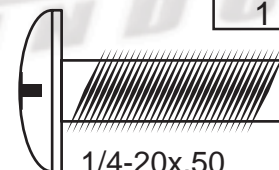

1/4-20x.50
Truss Screw

Installation Process

1

Remove Existing Screw

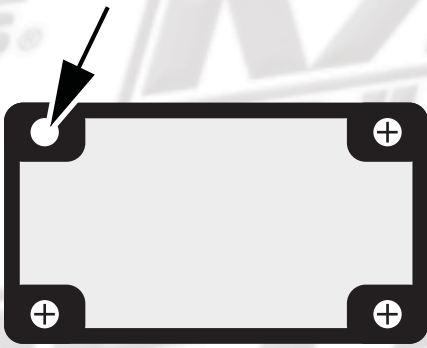

Pick where you want to mount the antenna and remove existing screw from either side of the license plate.

2

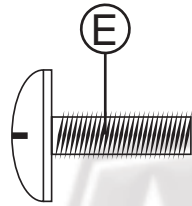
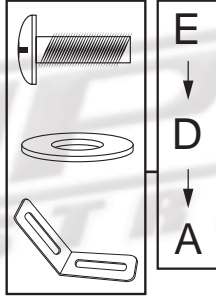

Find the Screw (E) and replace previous screw removed. Place a Regular Washer (D) between the license plate bracket and the Angle Antenna Bracket (A) on the backside of the license plate.

3

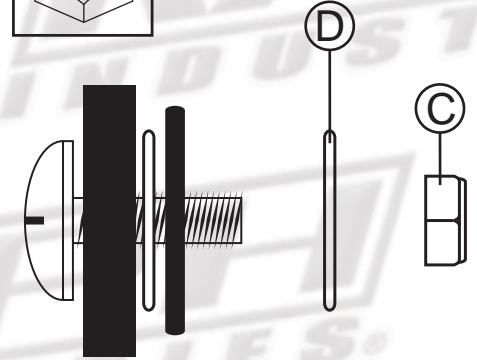
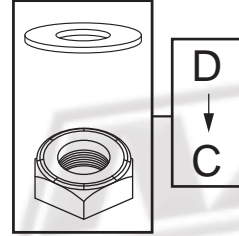

Place another Regular Washer (D) onto the Screw (E). Thread a Nylon Nut (C) onto the Screw (E) securing the Angle Antenna Bracket (A) to the license plate.

4

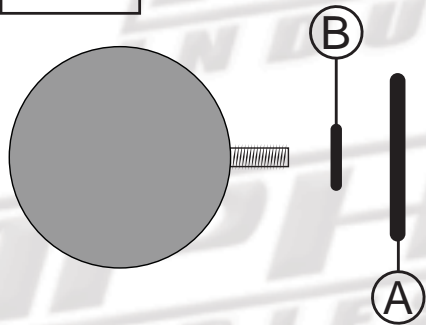
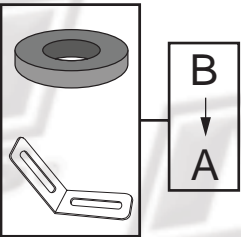

Using the adjacent side, place the Neoprene Washer (B) onto the stud of the antenna. Fit the stud through the screw slot on the Angle Antenna Bracket (A).

5

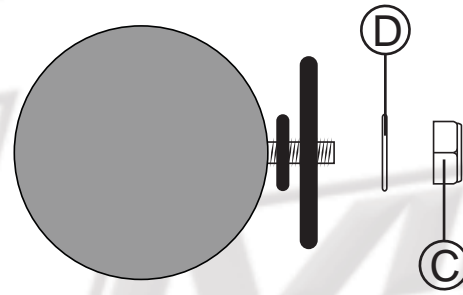
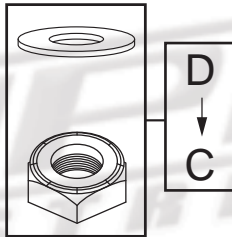

Fit a Regular Washer (D) onto the antenna stud opposite antenna. Secure the antenna to the Angle Antenna Bracket with a Nylon Nut (C).

6

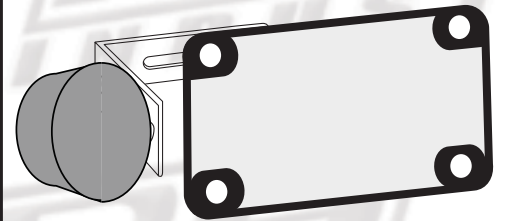

Tighten the new Screw (E) and the Nylon Nuts (C) added to secure the Angle Antenna Bracket (A) to the license plate.

7

Harley Davidson

License Plate
Antenna Bracket
Part# ai.951104

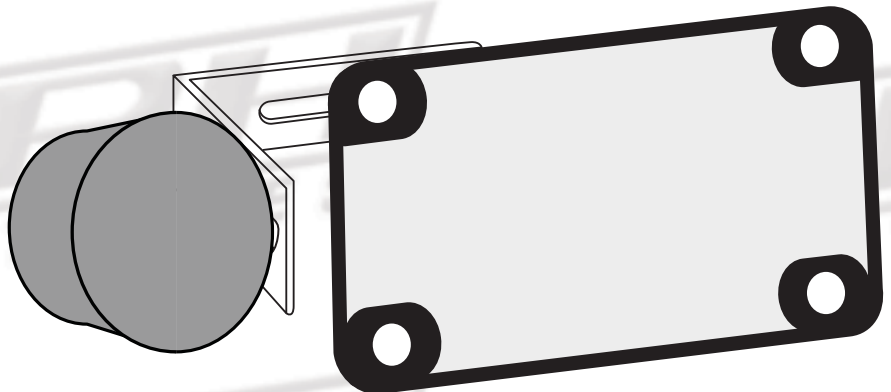

| ITEM | QUANTITY | PART NUMBER | DESCRIPTION |
|------|----------|-------------|-----------------------------|
| A | 1 | 909106 | Angle Antenna Bracket |
| B | 1 | 910067 | Neoprene Washer |
| C | 2 | 910068 | 1/4-20 Nylon Ins. Nut |
| D | 3 | 908340 | 1/4-20 Regular Plain Washer |
| E | 1 | 903798 | 1/4-20x.50 Truss Screw |

